



The experts for smart home products,
KNX building systems technology and much more.

VALUE

Best Price-Quality / Functionality Ratio.
Highest cost-performance in the market.

SERVICE

Fast and decisive Technical support service.
Possibility to provide OEM solutions.
Customization of our products,
materials or design on customers request.



Zhuhai Sation Technology Co.,Ltd.

Tel:+86-756-3628187/287/387

Fax:+86-756-2612730

Web:www.sation.com.cn

Email: sation-knx@outlook.com

3F-2 Blog B1,No.1 Software Road,

Zhuhai Hi-tech Zone,Zhuhai,Guangdong,China 519000

Zhuhai Sation Technology Co.,Ltd.

The first Chinese company that had a KNX protocol stack

BRAND INTRODUCTION

Sation manufactures and promotes various KNX functional modules and system components for smart building/home applications. We are Chinese enterprise which owns the intelligent building KNX core protocol software standard, Sation technology is focused on research and innovation in building efficiency, intelligence and energy-savings. Through the dedication to technical innovation and continued improvement, Sation technology has obtained various software copyrights, both at home and abroad, including over 10 patent intellectual property rights and over 20 software copyrights.

Home Automation Solution

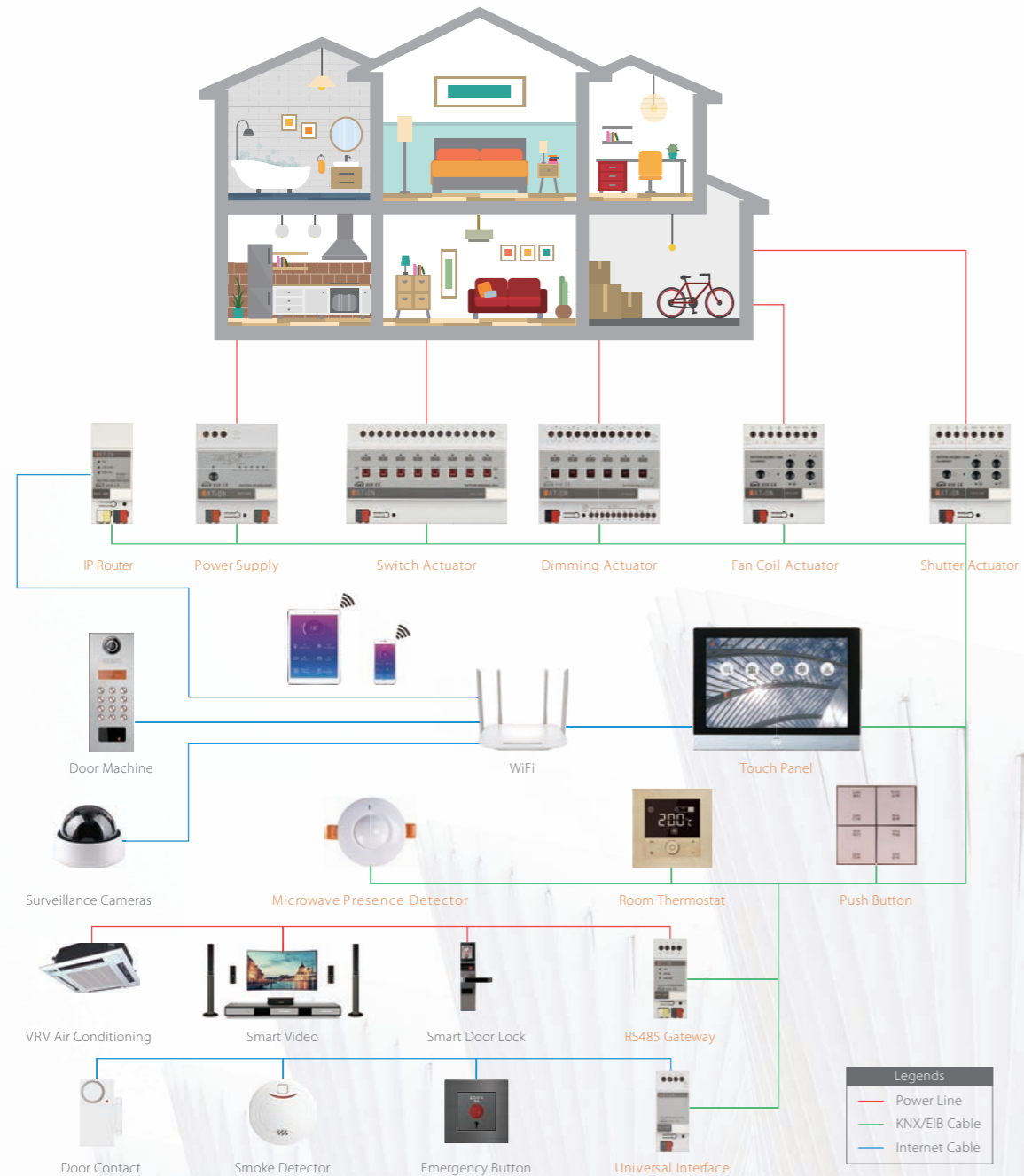

Hotel Automation Solution

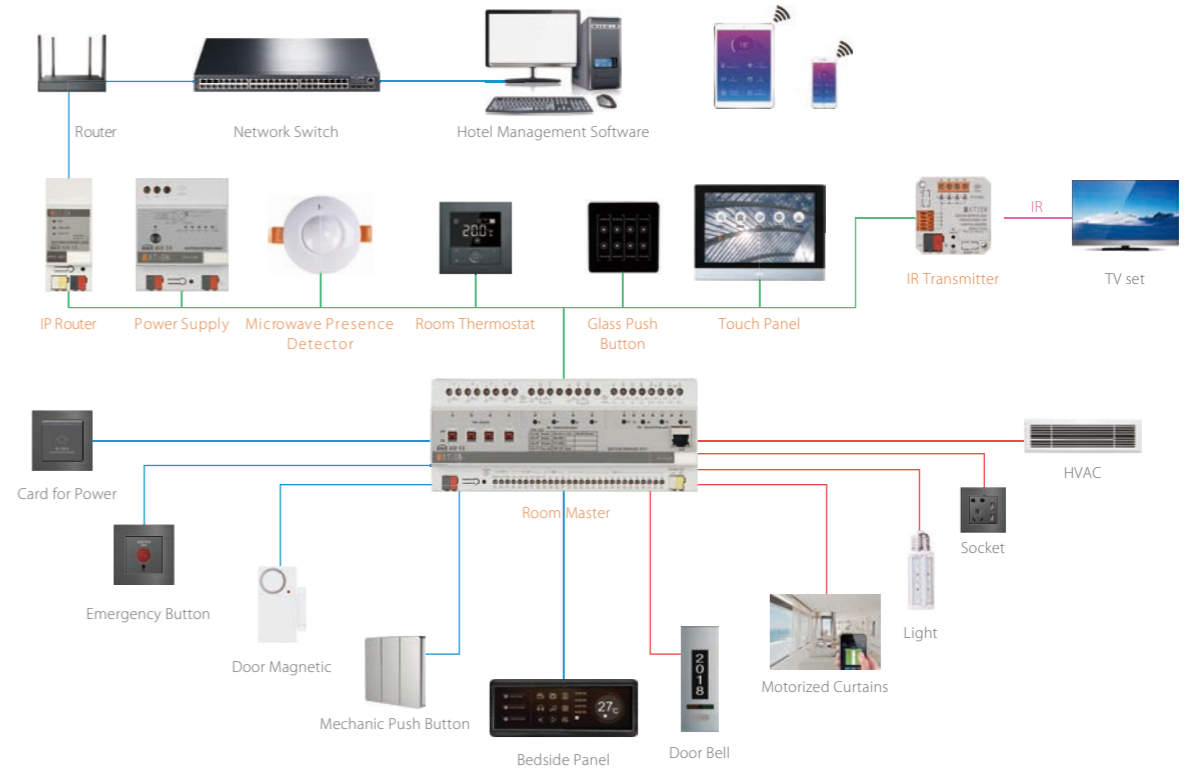

Office Automation Solution

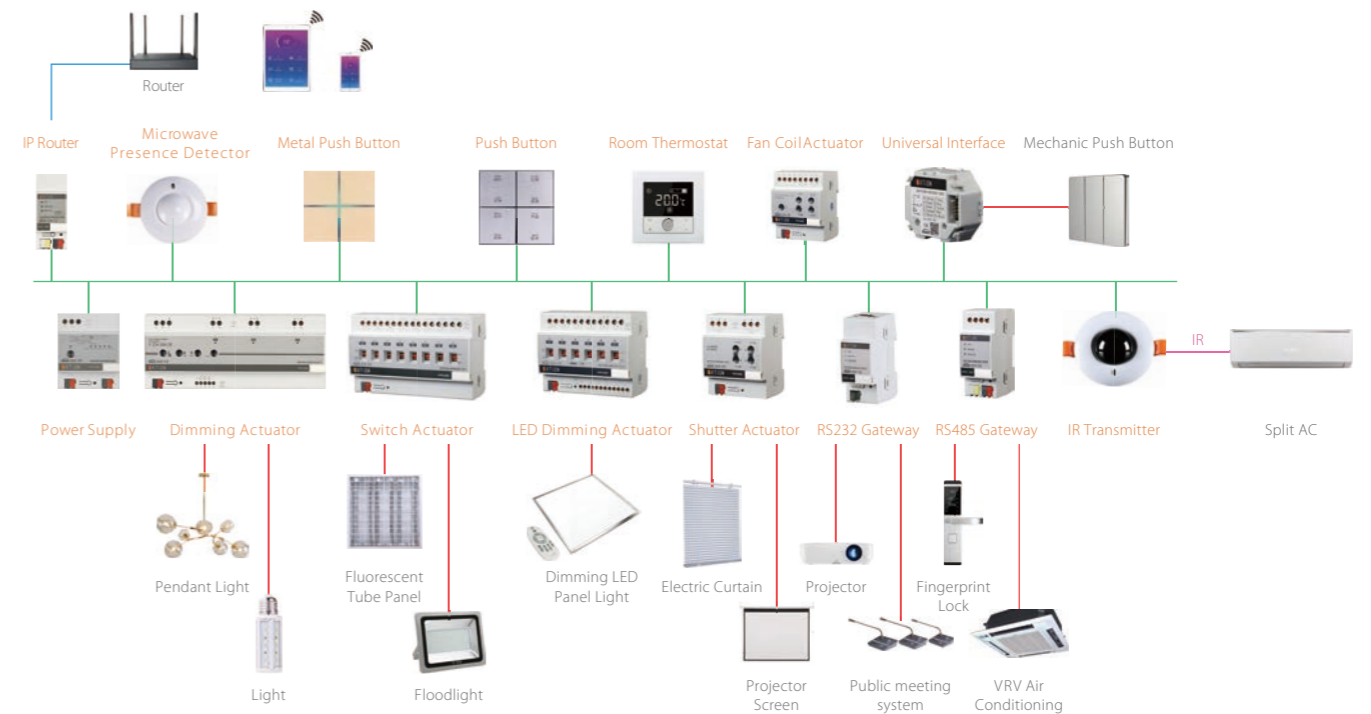

PRODUCT FUNCTION

DALI GATEWAY

SATION-GW2303.0401
SATION-GW2303.0402
SATION-GW2304.0401

72x90x63mm



- Support 16 scenes, scene number can be set separately; each scene A, B channel total 128 devices can be set separately;
- General control: support setting the brightness value of the lamp; support setting the switch time, absolute dimming time and relative dimming time separately;
- Operation mode: normal mode, dynamic mode, slave mode;
- Short address assignment: automatic assignment, manual assignment and address deletion;
- 64 channels of A channel can be individually dimmed and controlled, and 64 channels of B channel can be used for general control; (single channel gateway)
- Individual dimming control and status feedback for 128 devices in A and B channels; (dual-channel gateway)
- Support DT8 device type, Support colour control (Colour control gateway)

SWITCH/SHUTTER/DIMMING ACTUATOR

SATION-WD0201.0851
SATION-SW0003.0851
SATION-DM0101.0210

52x50x22mm

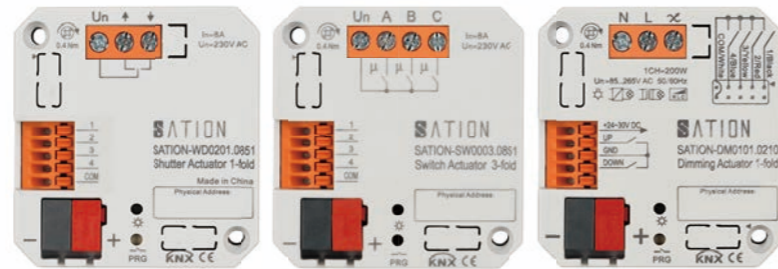

- 8A, HF relays, no hand switch
- Extensive staircase light and impulse functions
- Logical linking of binary data
- Adjustable behavior in case of bus voltage failure or return
- Time functions (switch-on/switch-off delay)
- Status response (active/passive) for each channel
- Extend scene functions for each channel
- Integrated Universal Interface 4-fold

PRODUCT FUNCTION

MICROWAVE/PIR PRESENCE DETECTOR CONSTANT LIGHT CONTROL



SATION-SS3001.0101
SATION-SS3002.0101
SATION-SS3003.0101
SATION-SS3004.0101

Dimension:92x53x68mm
Install:55x55mm

- Range of detection illuminance : 0.11 lux~6600lux
- 1-10 level sensitivity of motion detecte
- Flush mounted
- Motion detection angle H 360°, covered area 6-12m Ø
- Adjustable presence and presence sensitivity for day, night and alarm
- Detection of moving directionaster/slave function, scenes and logical functions
- Manual/automatic/semi-automatic modeit
- Day/night function, orientation light function
- Orientation light (brightness and time adjustable)
- Sensitivity separately adjustable for day/night/presence

FLEXIBLE SIMPLE THERMOSTAT

SATION-PM1424.312X

86x86x9mm



Flexible Simple Thermostat is a 6 keys panel plus thermostatic from machine multi-function, Five functions:
key function, air conditioning function, floor heating function, air plate function, fresh air function.
It has a 1.5-inch OLED display and supports Chinese and English displays.
Support proximity sensing function, can make device linkage.
The percentage of backlight and screen brightness can be adjusted by ETS software.
Temperature control panel without auxiliary power supply, KNX bus current <= 12 ma (@ KNX = 30 v).

PRODUCT DESCRIPTION

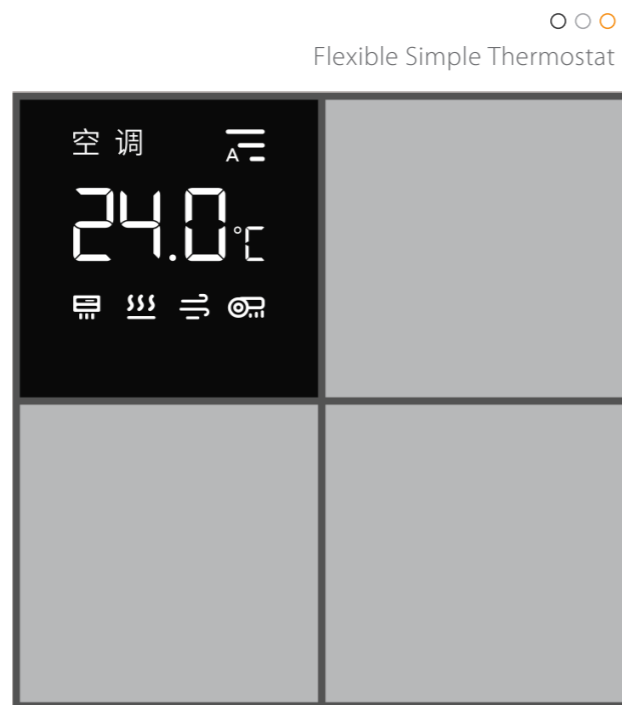

TOP MULTI-FACETED BORDER, RICH MATERIAL AND COLOR SELECTION

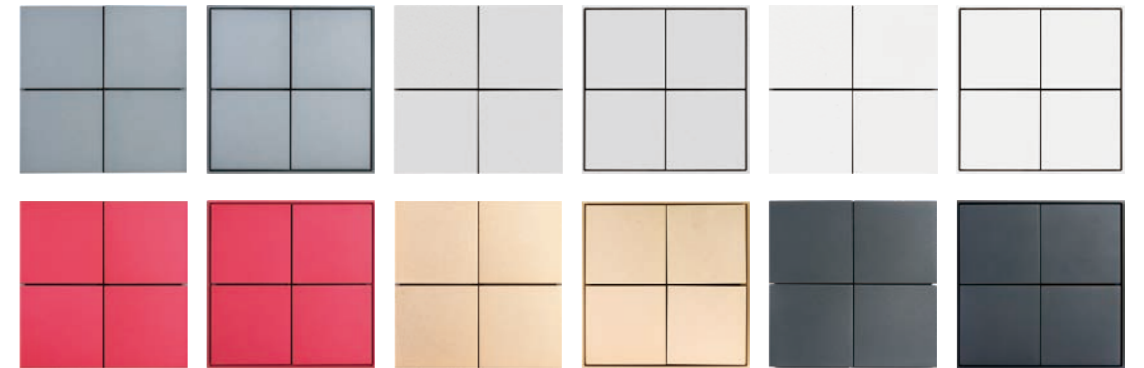

Push Button

- Key logo can be hollow
- Backlight LED;
- Orange/white LED indicator lights on the side
- Proximity sensing function
- (Titanium Black /Champagne Gold Gem Grey / Ceramic White Rose Red /Polar Silver, etc)
- Vibration feedback
- Dimming/Stutters/Switching /Scens Function
- Orced setting function for each output
- Operation with short/long button push and 2 objects

CUTTING-EDGE QUALITY FROM EUROPE

FLEXIBLE products in the switch series, mobile sensors and other products are advanced technology and design as a solid foundation. Just glance at it, you can feel the essence of FLEXIBLE new design concept: that is the pursuit of the most simple style. Stream-lined design, rich connotation. Form and function elements are integrated with each other to build a whole.



GUEST ROOM CONTROL UNIT

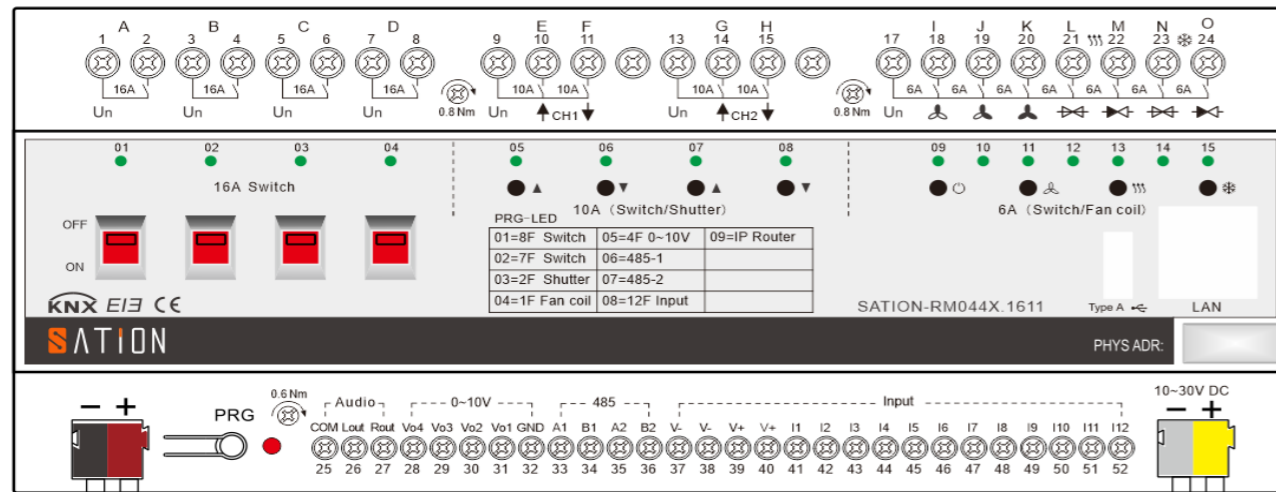

x4 LED Dimming Actuator

- Global and individual dimming speeds
- Parallel operation of 6 channels
- 8 scenes per channel
- Automatic time-dependent dimming
- Day/night function dimmer
- Unlimited power
- Live wire protection

x2 Shutter Actuator

- Status response (active/passive) for each channel
- Operation mode blind/shutter adjustable
- Absolute positioning for shutter and blinds
- Manual operation and LED indicator for each channel
- Operation mode blind/shutter Time control function
- Separate travel time for up and down adjustable
- Adjustable behavior in case of bus voltage failure or return
- Reverse direction protection

x12 Universal Interfaces

- Independent / Combined input function
- To connect pushbuttons or window/auxiliary contacts
- Adjustable debounce time for long keystroke
- Blocking function for each channel
- Operation with the short/long button push
- 12 Channels dry contact input

x1 FanCoil 4 Pipes

- Control of 3-speed fans/ventilator convectors
- 5A Suitable for 2-pipe/ 3-pipe systems and 4-pipe systems
- Output objects to control valves for heating/cooling
- Day/Night function to limit fan speed at night
- Control or automatic control of fans and valves, Status value query reply;
- Support bus voltage disconnect and recovery relay switch position selection, etc.

x4 Heating Outputs

- Two possibilities to control the heating valve
- Control two types of valve
- Locking function
- An automatic valve protection function

x2 RS485 Gateway

- Connected RS485 interface equipment
- Converting of data between KNX and Modbus
- Up to 17000 group address
- Scene function

x15 Switch Actuator

- Dimming/Switching/Shutters control/Scens functions
- Manual emergency switch 4 fold
- Current measurement range 20A 4 fold
- Two logic objects per channel
- Time functions (switch-on/off delay, Staircase light function)
- Status response (active/passive) for each channel

- 8 scenes per channel
- Central switching functions and block functions
- Adjustable behaviour in case of bus voltage failure or return
- Real time current measurement (mA, A, kW)
- Integrated counter to capture power consumption (Wh/kWh)
- Time meter



x1 IP Router

- To enable communication between LAN and the KNX bus
- 4 simultaneous connections possible
- Programming the KNX bus via TCP/IP
- Other building control software can realizing data interaction and control by connecting this equipment between ethernet and KNX net



- Complete Ethernet and line coupling, message exchange
- Automatically aware and set the network baud rate (10/100mb)
- Filtering, blocking and routing of group message



PRODUCT LIST

Picture	Name/Model	Dimension	Function
	<p>Push Button 8-fold</p> <p>SATION-PM1308.2101 SATION-PM1308.2102 SATION-PM1308.2103 SATION-PM1308.2104 SATION-PM1308.2105 SATION-PM1308.2106 SATION-PM1308.1101 SATION-PM1308.1102 SATION-PM1308.1103 SATION-PM1308.1104 SATION-PM1308.1105 SATION-PM1308.1106</p>	86x86x9mm	<p>Dimming Function:press long/short to dimming.</p> <p>Stutters Control: press long (move/stop), press short (stop/move)</p> <p>Switching Function:edge control, press long/short to control,edge reversal</p> <p>Scens Function:memory function,selection of different scense</p> <p>One button dimming:short press button to switching ,long press button to dimming.</p> <p>Sending of an second objects is possible by the logical modules</p> <p>Operation of blinds and shutters, 1 and 2 button operation</p> <p>Centered title block with cover for individual marking</p> <p>Push Buttons can be parameterized for 1 or 2 button operation</p> <p>NO or NC contact operation, programmable length of button push</p> <p>Forced setting function for each output</p> <p>Operation with short/long button push and 2 objects (black、silver、champagne、grayish black、brown、etc)</p>
	<p>Push Button 4/8-fold</p> <p>SATION-PM1304.2121 SATION-PM1304.2122 SATION-PM1304.2123 SATION-PM1304.2124 SATION-PM1304.2125 SATION-PM1304.2126 SATION-PM1304.1121 SATION-PM1304.1122 SATION-PM1304.1123 SATION-PM1304.1124 SATION-PM1304.1125 SATION-PM1304.1126</p> <p>SATION-PM1308.2121 SATION-PM1308.2122 SATION-PM1308.2123 SATION-PM1308.2124 SATION-PM1308.2125 SATION-PM1308.2126 SATION-PM1308.1121 SATION-PM1308.1122 SATION-PM1308.1123 SATION-PM1308.1124 SATION-PM1308.1125 SATION-PM1308.1126</p>		



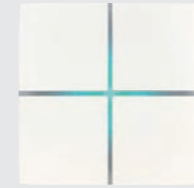

PRODUCT LIST

Picture	Name/Model	Dimension	Function
	<p>Flexible Simple Thermostat SATION-PM1424.312X</p>	86x86x9mm	<p>Flexible Simple Thermostat is a 6 keys panel plus thermostatic from machine multi-function, Five functions: key function, air conditioning function, floor heating function, air plate function, fresh air function.It has a 1.5-inch OLED display and supports Chinese and English displays.</p> <p>Support proximity sensing function, can make device linkage.The percentage of backlight and screen brightness can be adjusted by ETS software.Temperature control panel without auxiliary power supply, KNX bus current <= 12 ma (@ KNX = 30 v).</p>
	<p>Fan Coil Room Thermostat SATION-PM1423.1239</p>	86x86x9mm	<ul style="list-style-type: none"> • Temperature and relative humidity can be measured by internal integrated sensors, and can also be received by external bus.Temperature value measured by the unit.It can display the measurement value of temperature,setting value and relative humidity.Temperature display can be switched at C / F . • Room temperature control can be switched or proportional (PWM or continuous) adjustment. • Seasonal mode: heating and cooling can be switched locally or through bus. • Fan-coil units connected by 2-pipe or 4-pipe can be manually or automatically controlled. • Delay shutdown function. • With its own control relay, it can directly connect the fan coil unit. • Equipped with a set of two key button functions, can be configured to switch, dimming, curtain and scene functions.
	<p>Metal Touch Panel 4-fold SATION-PT1014.2632 SATION-PT1014.2638 SATION-PT1014.2631</p>	86x86x35mm	<p>Channel grouped function:</p> <ul style="list-style-type: none"> —Dimming:edge switch, short/long keystroke dimming. —Shutters: The short keystroke (Stop/Blinds Adjustment), The long keystroke (Shutter Down/up) —Switch:edge control <p>Channel unique function</p> <ul style="list-style-type: none"> —Switch: edge control, short/long keystroke control,edge reversal. —Scene:Saving function,select different scene —One Button Dimming: The long keystroke addresses the communication object Dimming on/off. —One Button Shutter: The long keystroke performs up- and down- movement of the shutter.





PRODUCT LIST

Picture	Name/Model	Dimension	Function
	Switch Actuator 1/4/6/8/12-fold 16A	36x90x63mm 72x90x63mm 108x90x63mm 144x90x63mm 216x90x63mm	<ul style="list-style-type: none"> • Current measurement range 10mA-20A • Each channel can be controlled independently and has an own supply phase • Time functions (switch-on/off delay, Staircase light function) • Status response (active/passive) for each channel • Logical linking of binary data, 8 scenes per channel • Central switching functions and block functions • Adjustable behaviour in case of bus voltage failure or return • Integrated True RMS current measurement (current, kW) • Time meter / Integrated counter to capture power consumption (Wh/kWh)
	Switch Actuator 2/4/6/8/12-fold 10A		
	LED Dimming Actuator 6-fold 0-10V	144x90x63mm	<ul style="list-style-type: none"> • Global and individual dimming speeds • Repetition of sequences for automatic color control • Parallel operation of 2 channels • Automatic color temperature control Dim2Warm • Automatic time-dependent dimming • Day/night functions MOS dimmer • Overcurrent and overtemperature supervisions
	Shutter Actuator 2/4-fold	72x90x63mm 144x90x63mm	<ul style="list-style-type: none"> • Status response (active/passive) for each channel • 8Bit positioning for shutter and blinds • Lockable manual operation and LED indicator for each channel • Operation mode blind/shutter • Time control function • Separate travel time for up and down • Adjustable behavior in case of bus voltage failure or return
	Fan Coil Actuator	72x90x63mm	<ul style="list-style-type: none"> • Control of 3-speed fans/ventilator convectors • 10A Suitable for 2-pipe/ 3-pipe systems and 4-pipe systems • Output objects to control valves for heating/cooling • Day/Night functions to limit fan speed at night • Control or automatic control of fans and valves, Status value query reply • Support bus voltage disconnect and recovery relay switch position selection, etc.

PRODUCT LIST

Picture	Name/Model	Dimension	Function
	Power Supply Choke 2U/320mA SATION-SP2003.3222	36x90x63mm	<ul style="list-style-type: none"> • Rated 320mA/640 mA (the total current of the two outputs); • 64 or less equipments configure 1 bus supply, specific quantity depends on total equipment consumption; • A KNX supply need to be paralled every 500 meter if line loss or voltage drop. • In-page and out-page supply need to be configured independently if using coupler paging. • Failure message by a telegram, Short-circuit-proof Overload safe, With additionally choke free output Integrated bus coupling unit with diagnosis function: Bus voltage, bus current, bus overload, Bus voltage failure/return • All events are stored with time stamp in a ring buffer
	Bus Power supply 4U/640mA (universal power input power level indication) SATION-SP2004.6440	72x90x63mm	
	Dimming Actuator 3/6-fold 600/200W	216x90x63mm	<ul style="list-style-type: none"> • Relative dimming/absolute dimming functions • Switch-on /off delay • Set the dimming time from 0% to 100% • Set illumination value, switch on and switch off speed • Automatic color temperature control Dim2Warm • Day/night functions • Overcurrent and overtemperature supervisions • MOS dimmer Scens Function
	Dimming Actuator 3-Fold 0-10V SATION-DM0103.0030	52x50x22mm	Used for brightness adjustment and switch control of LED lamps. With relative / absolute dimming mode, 0% ~ 100% dimming time can be set, on / off speed brightness value setting, scene function, delay on / off and other functions

PRODUCT LIST

Picture	Name/Model	Dimension	Function
	Line Coupler	36x90x63mm	<ul style="list-style-type: none"> • Connection - EIB/KNX bus terminals (0.8mm in diameter) • Line Coupler to connect two KNX lines to each other • Electrical isolation between the lines • Separate bus power supply for each line • Filter functions to reduce bus load • Support extended group addresses • To enable communication between PC and the KNX bus via USB • Full compatible to ETS3/4/5
	USB Interface SATION-GP2402.0201	36x90x63mm	<ul style="list-style-type: none"> • To enable communication between PC and the KNX bus via USB • Fully compatible to ETS3/4/5
	RS485 Gateway SATION-GW2302.0201	36x90x63mm	<ul style="list-style-type: none"> • To enable communication between PC and the KNX bus TCP/IP • Programming the KNX bus via TCP/IP • Power supply by KNX bus, no external bus power supply is required • Encrypted transmission at sending emails
	RS232 Gateway SATION-GW2301.0201		<ul style="list-style-type: none"> • Other building control software can realize data interaction and control by connecting this equipment to ethernet and KNX net • Connect 485/232 interface equipment • Convert of data point types
	IP Router SATION-GW2300.0201		<ul style="list-style-type: none"> • This product provides 6 SOCKET channels and supports 10/100M paired ethernet access • Also the KNX package can control ethernet by using this product, such as: <ol style="list-style-type: none"> 1) the control system requires ethernet and PC background to manage the software; 2) Other building control software can realize data interaction and control by connecting this equipment to ethernet and KNX net.

PRODUCT LIST

Picture	Name/Model	Dimension	Function
	Universal Interface 6-fold	48x41.5x19mm	<ul style="list-style-type: none"> • Dimming on/off • Switches on/off • Shutter down/up • Switch edge control/switching sequence • Scene function select different scene • Operation with short/long button push and 2 objects • Counting of pulses • Forced setting function for each output • LED output control
	Universal Interface 3-fold	36x90x63mm	
	Universal Interface 20-fold	45x52x11mm	
	Infrared Emitter (Flush mounted) SATION-GP2410.0304	52x50x22mm	
	IR Transmitter	Exterior: 92x53x68mm Hole: 55x55mm 52x50x22mm	<ol style="list-style-type: none"> 1. Connect traditional infrared equipment into KNX smart systems, and realized by KNX smart panel, IP or other KNX equipment. 2. Integrated infrared internal learning receiver, user unnecessary connected outside. It can realize learning and transmit function, unnecessary other debugging tools. 3. Learning any type of infrared signal whose carrier frequency is 38KHz. After successful learning, it has feedback information and can store 225 different codes. 4. Integrates part of the air conditioning remote control code, and the other infrared devices such as TV, set-up box can be controlled by learning function. <ul style="list-style-type: none"> • Storing up to 64 different IR functional control codes for per channel • Twilight/brightness channel with switching thresholds • Temperature channel with three switching thresholds • Ten logic functions • A channel can link up to 16 group addresses • IR functional control codes can be assigned to 1bit or 1byte type of object • Sending time and sending delay can be set for per control codes • Each main function can include 5 slave functions • The transmitting angle is full of direction