

0-10 V Dimming Actuator

Manual-Ver2.1

MD041601

MD061601

Catalog

1 Overview	1
2 Product and function overview.....	1
3 Detailed parameters.....	1
4 Dimensional drawing and wiring diagrams.....	2
4.1 MD041601	2
4.2 MD061601	2
5 Product operation instruction	3
5.1 MD041601	3
5.2 MD041601	3
6 Parameter setting and communication object description	5
6.1 Dimming function.....	5
6.2 Dry contact interface	8
6.3 Device situation	11
6.4 Description of communication object.....	12
7 Safe use and maintenance.....	14
8 Contact	15

1 Overview

This manual provides you with detailed technical information on the dimming actuator (0-10V) output, including installation and programming details, and explains how to use the dimming actuator (0-10V output) based on practical examples. For easy installation in the distribution box, the dimming actuator (0-10V output) is designed as a modular installation device, which can be installed on a 35 mm DIN rail.

Dimming actuator (0-10V output) is used to control 0-10V dimming.

Installed together with other loads via EIB/ KNX bus to become a system.

The entire system is set up and operated using the engineering design tool software ETS.

2 Product and function overview

The 4-way dimming actuator (0-10V) modules are modular installation devices with 4-way 0-10V outputs. EIB bus terminals are connected to EIB/KNX system, and ETS software (version ETS4.0 or above) is used for physical address allocation and parameter setting.

The execution module has 4 channels, each channel includes a relay switch output and a 0-10V output. 0-10V dimming signal interface and 0-10V dimming transformer can dimming incandescent, fluorescent, LED and other lamps. With manual control buttons, LED indicates the dimming status of each circuit.

Functions:

- (1) Control the regulator or electronic ballast through the 0-10V interface output;
- (2) With 4/6 way 16A switch control
- (3) With manual control dimming function;
- (4) It can realize relative dimming function and absolute dimming function;
- (5) With status report feedback function;
- (6) With timing cycle function, it can realize the function of stair light and cycle flashing;
- (7) It has the functions of on-site saving and restoring;
- (8) The selection function of the relay switch state after the bus voltage is restored;
- (9) With scene control function.
- (10) 4-way I/O input function, which can input control commands such as switches, curtains, dimming, and scenes.

3 Detailed parameters

Rated voltage	200~240V AC
Working frequency	50/60Hz
Bus voltage	21-30VDC
Bus current	≤12mA
Working frequency	< 3.2W (4 ways)

	< 4.2W (6 ways)
Output voltage	0-10VDC(output) , Each loop output Max.40mA
Relay switching current (per circuit)	Pure resistive load: Max 16A Incandescent: Max 10A Fluorescent lamps with electronic ballast: Max 4 A
Size(L x W x H)	145mmX90mmX64mm
Material	PA66
Weight(approx.)	0.36KG (4 ways) 、 0.4KG (6 ways)
Installation method	35mm DINDIN rail installation
Working temperature	-5°C- 45°C
Storage temperature	-20°C- 55°C
Relative humidity	max 90%

4 Dimensional drawing and wiring diagrams

4.1 MD041601

dimensional drawing

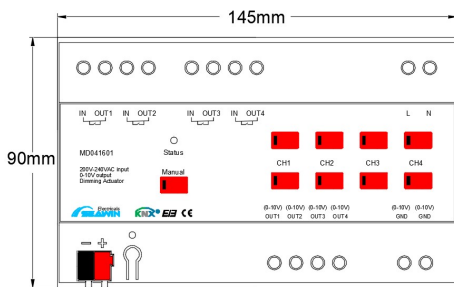

wiring diagram

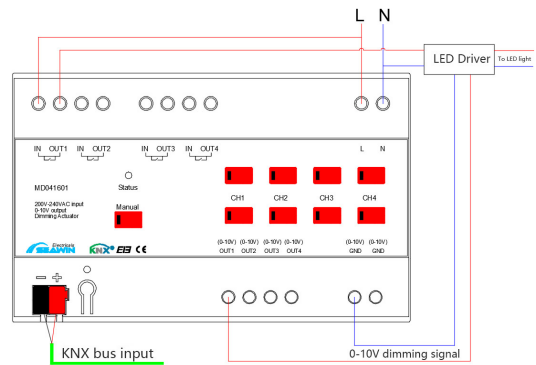

4.2 MD061601

dimensional drawing

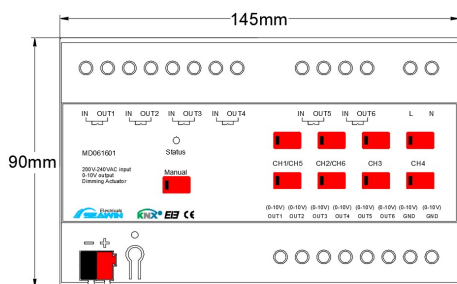

wiring diagram

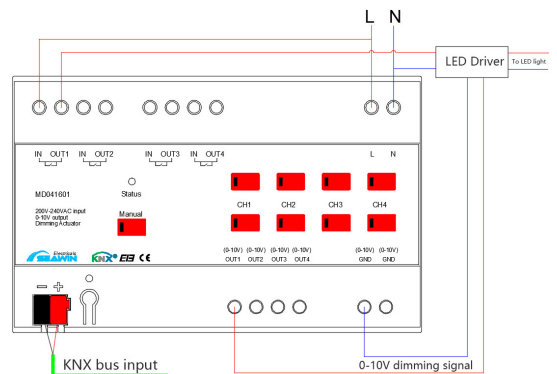

5 Product operation instruction

5.1 MD041601

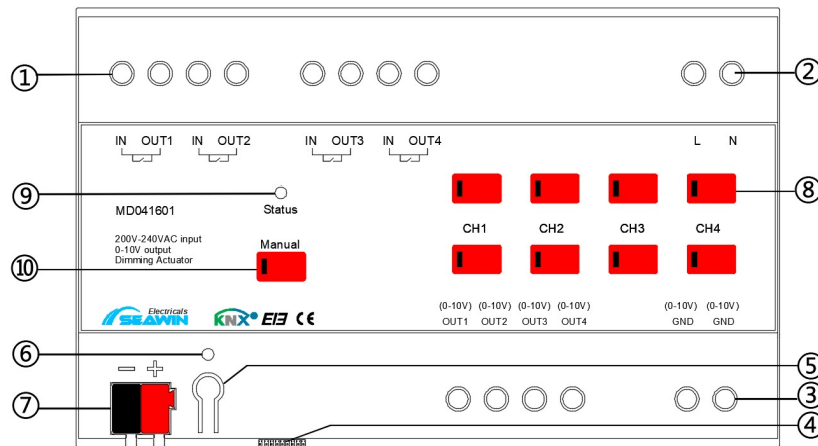

- Description: Relay output terminals: fire in and fire out, the aperture can be connected to $\phi 4$ wires;
- Description: 200~240VAC power supply connection port, the aperture can be connected to $\phi 4$ wire;
- Description: 0-10V output terminals, the aperture can be connected to $\phi 4$ wires;
- Description: dry contact input terminals;
- Description: programming button, short press the button to enter programming mode;
- Description: Programming indicator light, when the indicator light is red, the device is in the programming state, when the device is programmed or working normally, the indicator light is off;
- Description: KNX terminal block, KNX bus connection, the red line is connected to "+", and the black line is connected to "-";
- Instructions: Each loop control button, when the indicator light on the Manual button is on, long press the upper row button, the brightness of the corresponding channel will increase (maximum increase to the maximum brightness value set), release it to stop; short press the upper row button, the brightness value has been increased to the maximum value set; long press the bottom button, the brightness of the corresponding channel will decrease (minimum to 0%), release it to stop; short press the bottom button, the brightness value has been reduced to 0%. (The speed of dimming changes depends on the time set in the VD library, the indicator light on the button is on during the operation, and the indicator light is off when the operation is stopped or the operation is completed);
- Explanation: Status is the status indicator of the device power supply. When the indicator is green, the bus power supply status of the device is normal;
- Explanation: Manual is the switch button for bus and manual control. Press the button, the indicator light on the button will light up in red, and you can manually control the CH1-CH4 channels.

5.2 MD061601

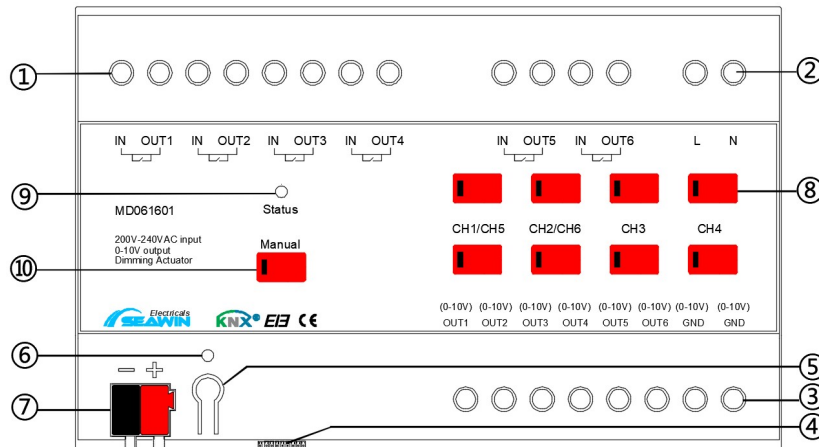

- Description: Relay output terminals: fire in and fire out, the aperture can be connected to $\phi 4$ wires;
- Description: 200~240VAC power supply connection port, the aperture can be connected to $\phi 4$ wire;
- Description: 0-10V output terminals, the aperture can be connected to $\phi 4$ wires;
- Description: dry contact input terminals;
- Description: programming button, short press the button to enter programming mode;
- Description: Programming indicator light, when the indicator light is red, the device is in the programming state, when the device is programmed or working normally, the indicator light is off;
- Description: KNX terminal block, KNX bus connection, the red line is connected to "+", and the black line is connected to "-";
- Instructions: Each loop control button, when the indicator light on the Manual button is on, long press the upper row button, the brightness of the corresponding channel will increase (maximum increase to the maximum brightness value set), release it to stop; short press the upper row button, the brightness value has been increased to the maximum value set; long press the bottom button, the brightness of the corresponding channel will decrease (minimum to 0%), release it to stop; short press the bottom button, the brightness value has been reduced to 0%. (The speed of dimming changes depends on the time set in the VD library, the indicator light on the button is on during the operation, and the indicator light is off when the operation is stopped or the operation is completed);
- Explanation: Status is the status indicator of the device power supply. When the indicator is green, the bus power supply status of the device is normal;
- Explanation: Manual is the button for bus and manual control and channel switching. Press the button, the indicator light on the button will light up red, and you can manually control the CH1-CH4 channels. Press the button again, the indicator light on the button will turn green, and you can manually control CH5 -CH6 channel, press the button again, the indicator light on the button is on and off, and it is in the bus control.

6 Parameter setting and communication object description

6.1 Dimming function

The following takes ETS5 as an example to set parameters in ETS5. Note: In the following introduction, Channel X or X represents the output of the corresponding channel.

1) Open the dimming actuator (0-10V output) parameter setting interface in ETS5, as shown in Figure 6.1.1. The parameter "Function select" indicates the function output selection, the parameter "Channel X" indicates the output of the corresponding channel, and the parameter "Field control" indicates the field control function. When the "off" command is sent, the current brightness percentage of each channel is saved and the channel is closed; When the "on" command is sent, the last saved relay state is recalled. (Note: You cannot send the "off" command twice consecutively, because the current dimming state is saved when the "off" command is sent for the first time, but when the "off" command is sent for the second time, the first dimming state will be saved. The full off state when the "off" command is sent, overwriting the current dimming state saved for the first time).

Available options: Disable, Enable

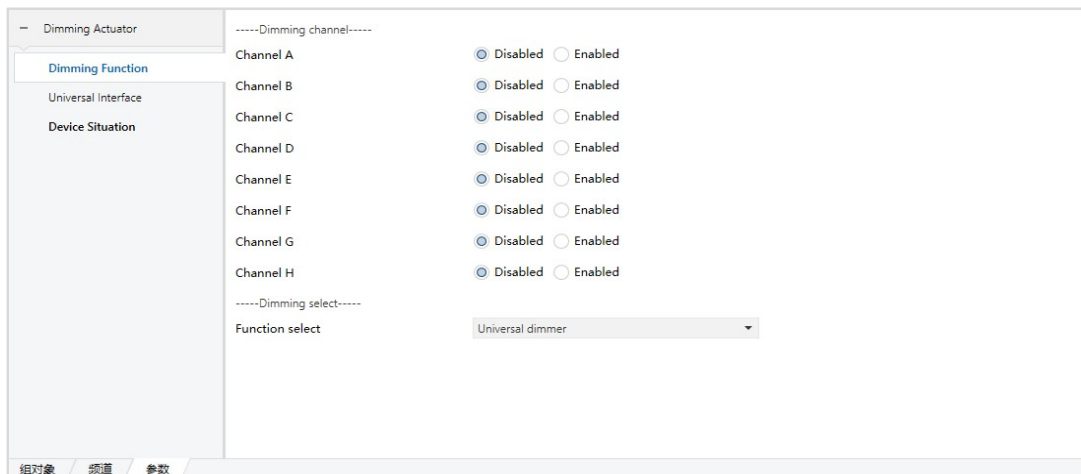

Figure 6.1.1

2) Select "Enable" for Channel X (Channel A~Channel H has a total of 8 circuits. If it is a 4-way dimming actuator, select "Enable" for Channel A-Channel D, and select "Disable" for the other 4 channels; if it is For 6-way dimming actuators, select "Enable" for Channel A—Channel F.) After the setting is completed, the interface is shown in Figure 6.1.2, and the 6 options in the red box appear.

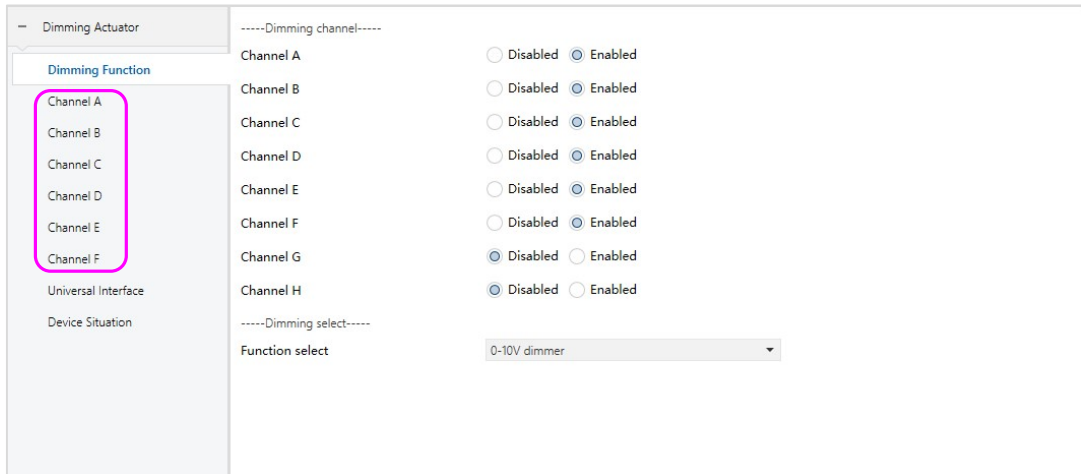

Figure 6.1.2

3) Click the options in the red block above to set the parameters of each circuit. Take Channel A as an example, as shown in figure 6.1.3

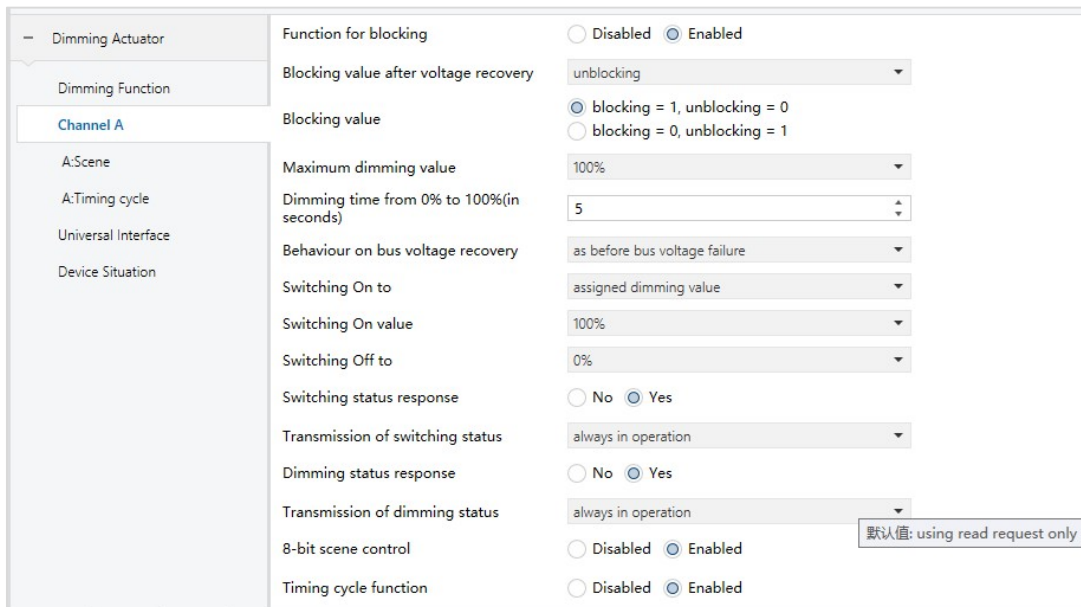

Figure 6.1.3

Parameter	Description
Function for blocking	Function for blocking, when "Enabled" is selected, parameter "Blocking value after voltage recovery" will appear, options: "unblocking" , "blocking" , "as before voltage failure" ; parameter "Blocking value" , options: "blocking=1, unblocking=0" .
Maximum dimming value	Maximum dimming value, options: 0%, 1%, 2%.....100%;
Dimming time from 0% to 100% [in seconds]	Dimming time from 0% to 100%, can be filled in: 0, 1, 2, 3.....250;
Behavior on bus	Action of dimming actuator after voltage recovery, options: "no action" , "dimming up" ,

voltage recovery	“dimming down” , “as before bus voltage failure” .
Switching On to	Indicates the dimming value when dimming is pressed, options: maximum dimming value, last dimming value, assigned dimming value; when assigned dimming value is selected, parameter Switching On value will appear, options: 1%, 2%, 3%.....100%
Switching Off to	Indicates the dimming value when dimming off is pressed, options: 1%, 2%, 3%.....100%
Switching status response	Switching status response, options: Yes, No. When Yes is selected, parameter transmission of switching status will appear, options: using read request only (Status response only when sending request) , on change in status (Status change immediately with status feedback), Always in operation (Feedback whenever control data is sent) .
Dimming status response	Dimming status response, options: Yes, No. When Yes is selected, parameter transmission of switching status will appear, options: using read request only (Status response only when sending request) , on change in status (Status change immediately with status feedback), Always in operation (Feedback whenever control data is sent) .
Behaviour on bus voltage recovery	Represents bus voltage recovery status after power failure, options: Switch on, Switch off, As before voltage failure;
8-bit scene control	Scene control function, options: Enable, Disable, when "Enable" is selected, "scene" will appear in the corresponding channel on the left side of the interface. Click "scene" and the interface will be switched as shown in figure 6.1.4. In the interface “Delay time before operation[0-255s]” represents the time that the scene is delayed when the scene is called, can be filled in: 0, 1, 2, 3.....255 " ; Channel A assignment 1—8" represents the setting of the scene number, which can be set to 1-64, and " Output dimming Value " represents the channel brightness corresponding to the scene number, options: 0%, 1%.....100%(
Timing cycle function	Timing cycle function, options: Enable, Disable, when “Enable” is selected, " Timing cycle " will appear in the corresponding channel on the left side of the interface, click “Timing cycle” , and the interface will be switched as shown in figure 6.1.5. In the interface “Brightness value” represents the maximum brightness value in a cycle, options: 0%, 1%, 2%.....100%; “Fade time of brighter[0-255s]” represents the gradient time from minimum brightness to maximum brightness, can be filled in: 0, 1, 2.....255s; “Brighten duration[0-255min]” indicates the time after which the maximum brightness is reached, can be filled in: 0, 1, 2.....255min; “Brighten duration[0-59s], indicates the time after which the maximum brightness is reached, can be filled in: 0, 1, 2.....59s; “Darkness value” represents the minimum brightness value in a cycle, options: 0%, 1%.....100%; “Fade time of darker[0-255s]” represents the gradient time from maximum brightness to minimum brightness, can be filled in: 0, 1, 2.....255s; “Darken duration[0-255min]” indicates the time after which the minimum brightness is reached, can be filled in: 0, 1, 2.....255min; “Darken duration[0-255s]” indicates

the time after which the minimum brightness is reached, can be filled in: 0, 1, 2.....255s;
 "Cycle number(0=unlimited) " Represents the number of cycles, can be filled in any value,
 where 0 means infinite loop.

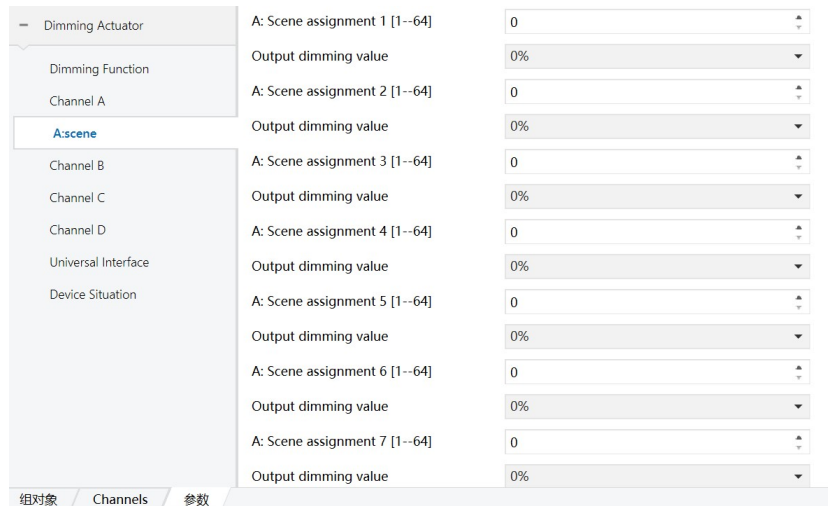

Figure 6.1.4

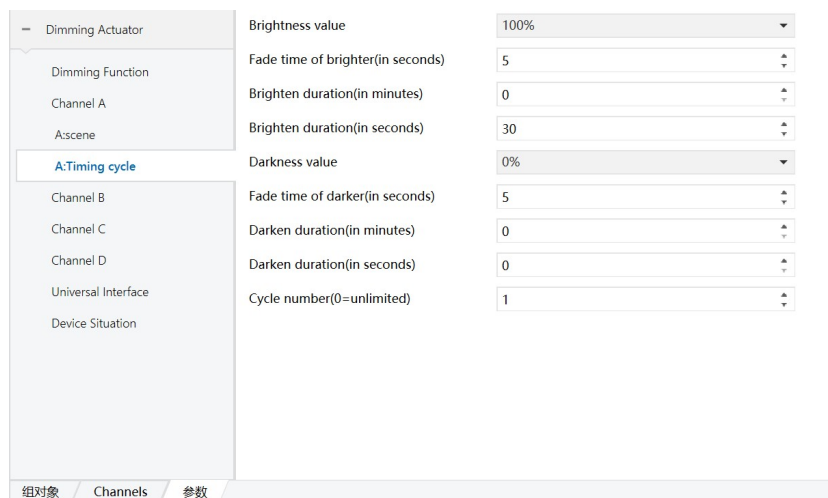

Figure 6.1.5

4) Parameter "function select" represents function select for dimming, options: "Universal dimmer", "0-10V dimmer", "1-10V dimmer" .

6.2 Parameter setting of dry contact interface

1) Click "Universal Interface" as shown in Figure 6.1.6, Universal Interface A-D is set to enable, four dry contact interfaces will be enabled.

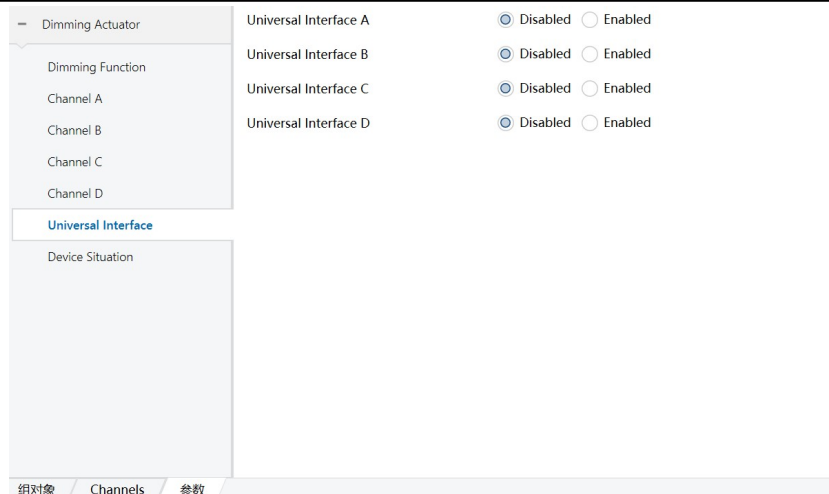

Figure 6.1.6

2) After the setting is completed, there will be Interface A-D four dry contact interfaces on the right. Click each dry contact interface to set its parameters. The following uses Universal Interface A as an example, as shown in Figure 6.1.7.

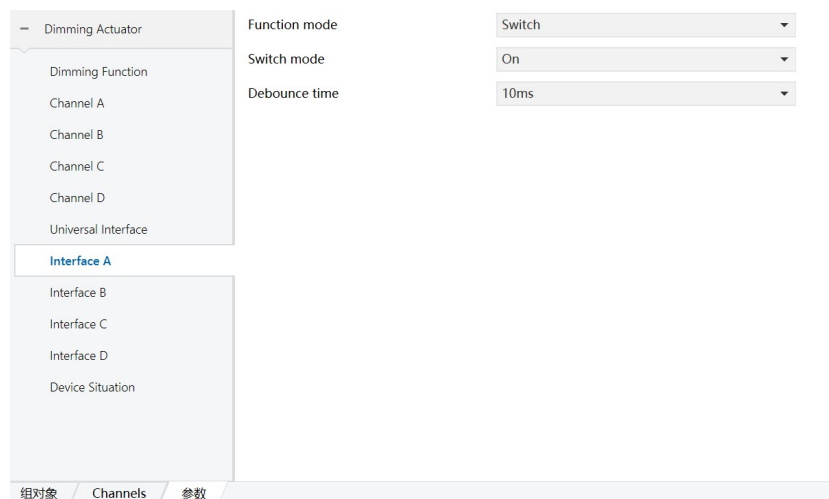

Figure 6.1.7

3) Parameter "function mode" is divided into 6 modes: Switch, Blind, Blind Position, Dimming, Dimming Position, Scene.

(1) Switch mode

Parameter	Description
Switch mode	Represents the action of the corresponding circuit control when the dry contact is triggered, options: on, off, toggle, user define; when user define is selected, The following parameters appear: (1) Reaction on closing the contact, options: on, off, no reaction; (2) Reaction on opening the contact, options: on, off, no reaction; (3) cyclic transmission of object, options: no, if "switch" =ON (relay on) , if "switch" =OFF (relay off) , always. When if "switch" =ON、if "switch" =OFF or always are selected, parameters will appear: transmission cycle time: base and Time factor[1-255] (Here the two parameters indicate the time interval between cyclic transmissions, transmission cycle time = base value × Time

	factor[1-255] value) .
debounce time	Debounce time, options: 10ms, 20ms.....100ms

(2) Blind mode

Parameter	Description
Blind mode	Curtain action controlled by corresponding circuit when dry contact is triggered, options: up, down, toggle;
Long operation	Long press operation, options: yes, no. When yes is selected, parameter "Long operation after" will be added, options: 0.5s, 1s, 2s.....7s; The interval of data(base:0.1s) represents the interval at which each piece of data is sent during a long press, can be filled in: 1, 2, 3 ... 255;
debounce time	Debounce time, options: 10ms, 20ms.....100ms

(3) Blind Position mode

Parameter	Description
Blind value (Range:0-255)0-100%	Represents the percentage of the position of the corresponding circuit control curtain when the dry contact is triggered. It can be filled in: 0-255;
debounce time	Debounce time, options: 10ms, 20ms.....100ms

(4) dimming mode

Parameter	Description
Dimming mode	Represents the dimming action controlled by the corresponding circuit when the dry contact is triggered, options: Dimming up, dimming down, toggle;
Long operation after:	Represents a corresponding action after a long press, options: 0.5s, 1s, 2s.....7s
Transmission mode for long operation	Data transmission mode when long press, options: One-time transmission, cyclic transmission.
Step dimming	Represents the amplitude of dimming, options: 100%、50%、25%、12%、6%、3%、1%
Send stop instruction when releasing	Command to stop when long press is released, options: No, Yes
debounce time	Debounce time, options: 10ms, 20ms.....100ms

(5) Dimming position mode

Parameter	Description
Dimming value (Range:0-255)0-100%	It indicates the brightness percentage of the corresponding circuit control dimming when the dry contact is triggered. It can be filled in: 0-255;
debounce time	Debounce time, options: 10ms, 20ms.....100ms

(6) Scene mode

Parameter	Description
Scene number	Represents the scene number called when the dry contact is triggered. It can be filled in:

	1-64;
debounce time	Debounce time, options: 10ms, 20ms.....100ms

6.3 Device Situation

1) Click "Device Situation" , parameter in Figure 6.3.1 will show:

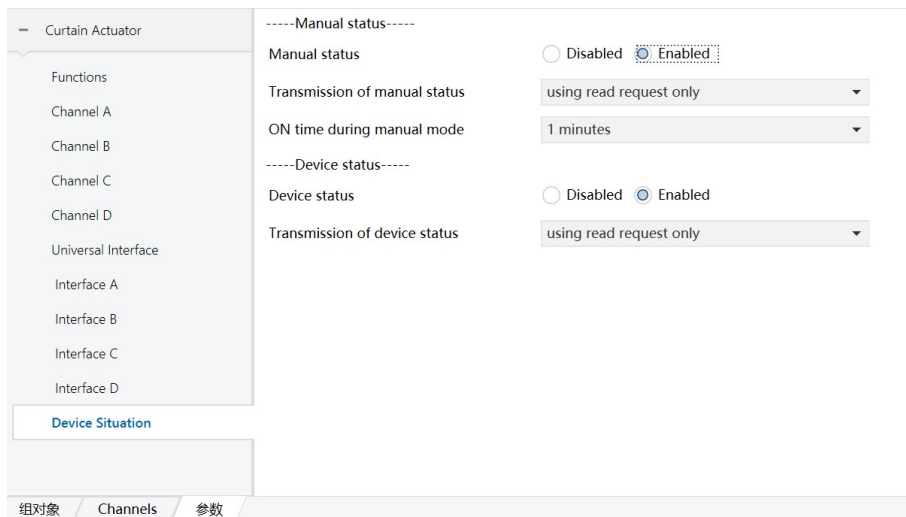

Figure 6.3.1

(1) Manual status indicates manual status. The following parameters appear when "enabled" is selected.

Parameter	Description
Transmission of manual status	Transmission of manual status, options: "using read request only" (Status response only when sending request) , "on change in status" (Status change immediately with status feedback) 、 "transmission in cycles" ; when "transmission in cycles" is selected, parameter "the time in cycles" (Interval time) , will appear, options: 1second, 2seconds..... 120minutes.
ON time during manual mode	ON time during manual mode, options: "1 minute" , "2minutes "..... "120 minutes" , "unlimited" .

(2) Device status the following parameters appear when "enabled" is selected.

Parameter	Description
Transmission of manual status	Transmission of manual status, options: "using read request only" (Status response only when sending request) , "on change in status" (Status change immediately with status feedback) 、 "transmission in cycles" ; when "transmission in cycles" is selected, parameter "the time in cycles" (Interval time) , will appear, options: 1second, 2seconds..... 120minutes.

6.4 Communication object description

The communication object is the medium for the device to communicate with other devices on the bus, that is, only the communication object can perform bus communication. The role of each communication object is described in detail below.

The dimming actuator has a total of 97 objects, as shown in Figure 6.2.1, and the specific functions are shown in Table 1.1.

Note: in the column of table properties, "C" represents the communication function enable of the communication object, "W" represents the value of the communication object can be rewritten through the bus, "R" represents the value of the communication object can be read through the bus, "T" represents the communication object has the transmission function, and "U" represents the value of the communication object can be updated.

序号 *	名称	对象功能	描述	群组地址	长度	C	R	W	T	U	数据类型	优先级
0	Channel A, Block	Block / Unblock			1 bit	C	R	W	T	U	switch	低
2	Channel A, Switching	On / Off			1 bit	C	R	W	T	U	switch	低
3	Channel A, Dimming	Brighter / Darker			4 bit	C	R	W	T	U	dimming c...	低
4	Channel A, Dimming value	8-bit Value			1 byte	C	R	W	T	U	percentag...	低
10	Channel B, Switching	On / Off			1 bit	C	R	W	T	U	switch	低
11	Channel B, Dimming	Brighter / Darker			4 bit	C	R	W	T	U	dimming c...	低
12	Channel B, Dimming value	8-bit Value			1 byte	C	R	W	T	U	percentag...	低
18	Channel C, Switching	On / Off			1 bit	C	R	W	T	U	switch	低
19	Channel C, Dimming	Brighter / Darker			4 bit	C	R	W	T	U	dimming c...	低
20	Channel C, Dimming value	8-bit Value			1 byte	C	R	W	T	U	percentag...	低
26	Channel D, Switching	On / Off			1 bit	C	R	W	T	U	switch	低
27	Channel D, Dimming	Brighter / Darker			4 bit	C	R	W	T	U	dimming c...	低
28	Channel D, Dimming value	8-bit Value			1 byte	C	R	W	T	U	percentag...	低
64	Switch, Interface A	On / Off			1 bit	C	R	W	T	U	switch	低
72	Switch, Interface B	On / Off			1 bit	C	R	W	T	U	switch	低
80	Switch, Interface C	On / Off			1 bit	C	R	W	T	U	switch	低
88	Switch, Interface D	On / Off			1 bit	C	R	W	T	U	switch	低
96	Manual status	On / Off			1 bit	C	R	W	T	U	switch	低
97	Device status	On / Off			1 bit	C	R	-	T	U	switch	低

Figure 6.2.1

Number	Name	Communication object function	Data type	Attribute
0,8,16,24,32,40,48,56	Channel A, Block	Block / Unblock	1bit	C,R,W,T,U
This communication object is used to enable and contact the blocking function. When the value "01" is sent, the blocking function is enabled. This circuit cannot send any value to the bus control device. When the value "00" is sent, the blocking function is released, and the dimming actuator receives and sends normally. data.				
1,9,17,25,33,41,49,57	Channel X, Scene	8-bit Value	1 Byte	C,R,W,T
This communication object is enabled when the parameter "8-bit scene control " of "Channel X" selects "Enable". This communication object can send a 1-byte command to call the setting operation of corresponding scene number. The parameter setting options are 1 ~ 64. In fact, the scene message received by the communication object Scene, Channel X is 0 ~ 63. If the parameter is set to scene 1, the communication object Scene, Channel X receives the scene is 0				
2,10,18,24,32,40,48,56	Channel X, Switching	On/Off	1 bit	C,R,W,T
The communication object is enabled when the parameter " Channel X " selects "Enable", the communication object				

receives 1, turn on the relay and adjust the dimming to the set maximum value; when the communication object receives the value "0", close the relay after the dimming output reaches the minimum				
3,11,19,27,35,43,51,59	Channel X, Dimming	Brighter/Darker	4 bit	C,R,W,T
The communication object is enabled when the parameter " Channel X " selects "Enable", this object is used to receive the relative dimming value of the corresponding output channel. Dimming commands include Brighter, Darker, and Stop.				
4,12,20,28,36,44,52,60	Channel X, Dimming Value	8-bit Value	1 Byte	C,R,W,T
The communication object is enabled when the parameter " Channel X " selects "Enable", this object is used to receive the absolute dimming value of the corresponding output channel.				
5,13,21,29,37,45,53,61	Channel X, Timing cycle	On/Off	1 bit	C,R,W,T
The communication object is enabled when the parameter "Timing cycle function" in " Channel X " selects "Enable", when the communication object receives the value "1", the cyclic dimming function is executed; when the communication object receives the value "0", the cyclic dimming function stops.				
6,14,22,30,38,46,54,62	Channel X, Status switching	On/Off	1bit	C,R,T
The communication object is enabled when the parameter "Switching status response" in " Channel X " selects "Yes", the value of this communication object can directly indicate the dimmer switch status of the corresponding channel.				
7,15,23,31,39,47,55,63	Channel X, Status dimming value	0-100%	1 Byte	C,R,T
The communication object is enabled when the parameter "Dimming status response" in " Channel X " selects "Yes", the value of this communication object can directly indicate the dimming percentage of the corresponding channel.				
64,72,80,88	Switch, Interface X	On/Off	1 bit	C,R,W,T
This communication object is enabled when "Function mode" in "Interface X" selects "Switch". When the dry contact is triggered, the channel sends corresponding ON or OFF instructions according to the corresponding mode.				
65,73,81,89	Blind, Interface X	Up/Down	1 bit	C,R,W,T
This communication object is enabled when "Function mode" in "Interface X" selects "Blind", when the dry contact is triggered, the channel sends the corresponding up or down instruction according to the corresponding mode.				
66,74,82,90	Blind, long, Interface X	Up/Down	1 bit	C,R,W,T
This communication object is enabled when "long operation" in "Blind" of "Interface X" selects "yes", when the dry contact is triggered by long press, the channel sends the corresponding up or down instruction according to the corresponding mode.				
67,75,83,91	Blind value,Interface X	8-bit value	1 Byte	C,R,W,T
This communication object is enabled when "Function mode" in "Interface X" selects "Blind position", when the dry				

contact is triggered, the channel sends the corresponding curtain height percentage instruction according to the corresponding mode.				
68,76,84,92	Dimming switch, Interface X	On/Off	1 bit	C,R,W,T
This communication object is enabled when "Function mode" in "Interface X" selects "Dimming", when the dry contact is triggered by a short press, the channel sends the corresponding dimming on/off instruction according to the corresponding mode.				
69,77,85,93	Dimming switch, Interface X	Brighter/Darker	4 bit	C,R,W,T
This communication object is enabled when "Function mode" in "Interface X" selects "Dimming", when the dry contact is triggered by a long press, the channel sends corresponding series of relative dimming instructions according to the corresponding mode				
70,78,86,94	Dimming switch, Interface X	8-bit value	1 Byte	C,R,W,T
This communication object is enabled when "Function mode" in "Interface X" selects "Dimming position", when the dry contact is triggered, the channel sends absolute dimming instructions according to the setting percentage.				
71,79,87,95	Scene, Interface X	8-bit value	1 Byte	C,R,W,T
This communication object is enabled when "Function mode" in "Interface X" selects "Scene", when the dry contact is triggered, the channel sends corresponding scene control instructions according to the corresponding mode.				
96	Manual status	On/Off	1 bit	C,R, T
The communication object is enabled when the parameter " Manual status " selects "Enable", this communication object is used to indicate the switch of manual mode (Manual mode=on) and bus mode (Manual mode=off) . When switching to manual mode (press the bus on the switch actuator and the manual control switch button, the "Manual" indicator lights up), you can control the on / off of each circuit on the corresponding button on the module.				
97	Device status	On/Off	1 bit	C,R, T
This communication object is enabled when the parameter "Device status" is selected to be "enabled". This communication object is used to detect the current condition of the device. When the value "01" is sent through this object, it indicates that the 220V power supply is normal. When the value "00" is sent, it indicates that the 220V power supply is abnormal.				

7 Safe use and maintenance

- (1) Read all instructions carefully before use.
- (2) Create a good ventilation environment.
- (3) During use, pay attention to moisture, shock and dust.
- (4) Strictly forbid to rain, contact with other liquids or corrosive gases.
- (5) If it is wet or attacked by liquid, it should be dried in time.
- (6) When the machine fails, please contact professional maintenance personnel or our company.

8 Contact

Address:9th Floor, Building 5, Aotelang Science and Technology Park, No. 68, Nanxiang 1st Road, Huangpu District, Guangzhou City, Guangdong Province.China

Tel: +86-20-82189121

Fax: +86-20-82189121

Website: <http://www.seawin-knx.com>