

VIDEO DOOR PHONE

USER MANUAL



7 inch TFT monitor
2 wire apartment system
ABS Engineering Plastics
Support smartphone connection
Talk, Monitor, Unlock, Inner intercom

VIDEO DOOR PHONE



1. Parts and Functions

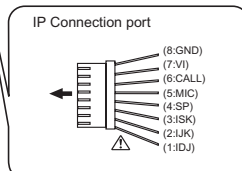
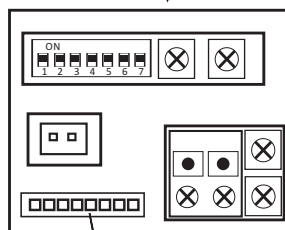
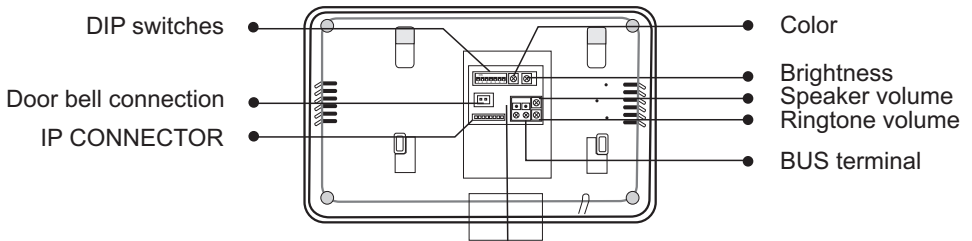
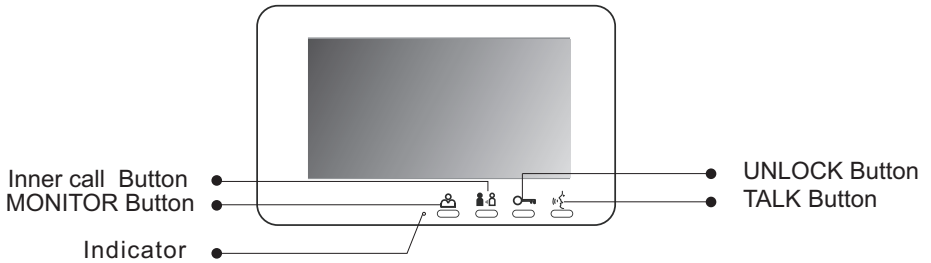



Indicator



Indicator light colors description

- Cyan--During Inner call;
- Green--During outdoor station calling;
- Green flashing--When user has missed the calling, who can press any buttons to delete this;
- Pinkish purple--During monitor the extra camera setting ;
- Yellow--During internal room ID number setting.

2. Operation Instructions

2.1 Answering a door call



Press **CALL** button on door station, the monitor rings, the **CALL** visitor can be seen on the monitor screen. If nobody answers the call, the screen will automatically turn off in 30 seconds.

To answer an incoming call, press  to answer, calls last for 90 seconds. you **DO NOT** have to hold talk to enable voice communication. Press  again to end the conversation. If the system connects with two or more monitors, answering any monitor, the others will turn off automatically.



2.2 Door Release

During the conversation with the visitor, press  button to unlock the door.

2.3 Monitoring





Press  button while in standby mode you will be able to see the view of outdoor station camera. Press  again switch to next door station camera or extra camera. Press  button twice to exit. (firstly you should have finish setting door station camera and extra camera, see below list).

How to set door station camera and extra camera?





Keep pressing   button until you hear a long beep. Start setting state of multiple door station and extra camera, and now the indicator light is pinkish purple. Press  as many times as the quantity of specific code of door state.

For example :

There are 3 door stations, 2 door station with extra camera, specific code of door state is 8.

Keep press   (Long beep) – press  8 time – press  .

There are 1 door stations, 0 door station with extra camera, specific code of door state is 1.

Keep press   (Long beep) – press  1 time – press  .

Door state	Specific code	Door state	Specific code
1 Door 0 Cam	Code=1	3 Door 2 Cam	Code=8
1 Door 1 Cam	Code=2	3 Door 3 Cam	Code=9
2 Door 0 Cam	Code=3	4 Door 0 Cam	Code=10
2 Door 1 Cam	Code=4	4 Door 1 Cam	Code=11
2 Door 2 Cam	Code=5	4 Door 2 Cam	Code=12
3 Door 0 Cam	Code=6	4 Door 3 Cam	Code=13
3 Door 1 Cam	Code=7	4 Door 4 Cam	Code=14

2.4 Inner Call

User can call other apartments by long pressing  until a beep sound to enter the internal room ID number setting and now the indicator light is yellow. To start the inner call, first you need to setup a dial number on the monitor.

How to setup the dial number on the monitor?

Keep pressing  button until you hear a long beep. Start setting 2 digit dial number.

 button refers to first digit 1~9

 button refers to 0 / confirm.

Eg. Set the dial number to 09.

press  (Long beep) – press  – press  9 times – press 

Set the dial number to 10.





press  (Long beep) – press  1 time – press  –press 

Set the dial number to 12.

press  (Long beep) – press  1 times – press  – press  2 times –press 

2.5 How to change the ring tone?

Please have a check the ringtones list at below.

Long press and hold the  button until the ringtone sounds and the indicator light will turn blue. Click the  button to switch to the next song, click the  button to return to the previous song . After selecting your favorite ringtone, click the  button again to save the settings.

58 Ringtones for optional.

No.	Song name	No.	Song name	No.	Song name	No.	Song name
1	dingdong_x2	16	The dawn	30	Carmen overture	45	Hungarian Dance
2	dingdongx2	17	Turkey March	31	Chinese folk music	46	Minuet in G major
3	Westminster Chimes	18	Alarm	32	dog	47	Auld Lang Syne
4	For Alice	19	The GreatCompassionate	33	Chinese folk music	48	Chinese Dance
5	Bird	20	Mantra 1812 Overture	34	Autumnin Paris	49	Dancer
6	Cock	21	The MoonOver ^a	35	Russe Dance Fountain	50	Toreador Song
7	Telephone ringing	22	Twinkle Twinkle Little	36	Red River Valley Star	51	Lullaby
8	Wolf	23	Waltz of the flowers	37	Four seasons spring	52	Greens leeves
9	Moonglow	24	Drinking Song	38	Schubert Serenade	53	HappyNewYear
10	Canon	25	Trout quintet	39	Wewish you a merry Christmas	54	Song Bird
11	Yesterday Once More	26	Circus troupe	40	Ave Maria	55	Chopin Waltz
12	Bell+ Cuckoo	27	Danceof the Little	41	Toy soldier marches Swans	56	Songof herding sheep
13	The cuckoo waltzes	28	Fiddler on the roof	42	Odeto Joy	57	Happybirthday
14	ringtone	29	DreamGod	43	Eva' s Polka	58	Cucurbit flute
15	Chinese folk music			44	RageOver a Lost Penny		

3. Monitor Mounting

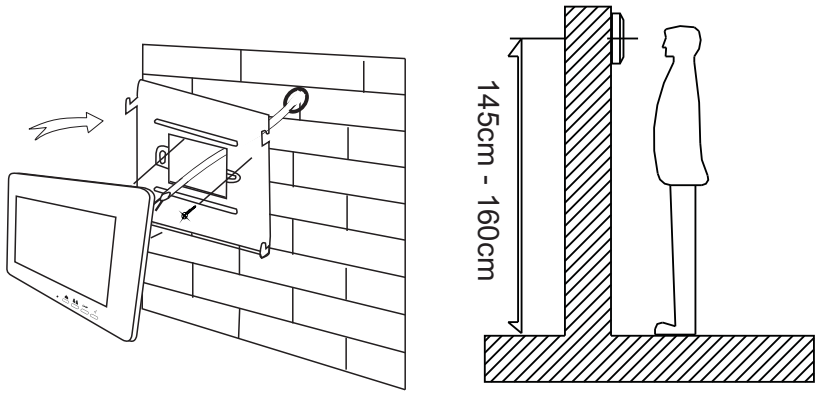

Using the screws to fix the Mounting Bracket on the wall.
Connecting the system correctly, then hang the Monitor on the mounting bracket firmly

Basic wiring

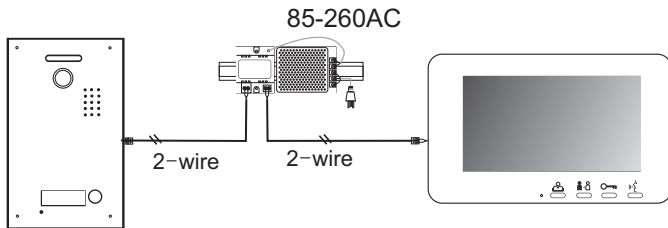

With IP Module Wiring

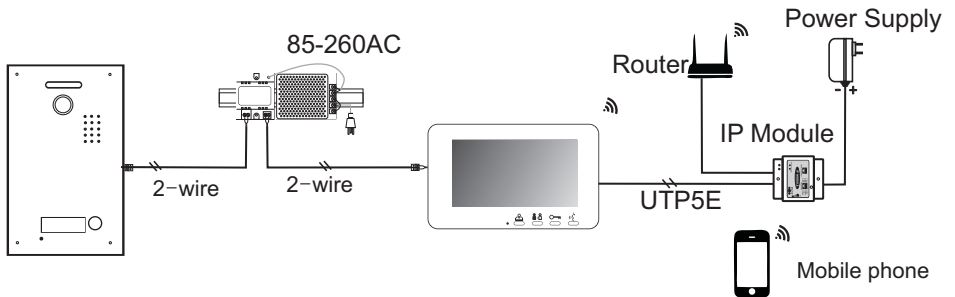

4. User Codes (Monitor bit codes) Setup

- Every room station must have an **ID**, set through the bit codes(list below)
- Bit-1 to Bit-5 are used to configure the room **ID**.
- Bit-6 is the line-terminal switch, set the **LAST** monitor to **ON**, otherwise set **OFF**.
- Bit-7 is to turn the ringtone at the door station **ON/OFF**.
- You can have a Max of 4 monitor per button/code.

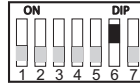
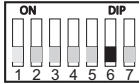

Monitor NOT at the end of the line

Monitor at the end of the line

Bit state	User Code	Bit state	User Code	Bit state	User Code
	Code=1		Code=12		Code=23
	Code=2		Code=13		Code=24
	Code=3		Code=14		Code=25
	Code=4		Code=15		Code=26
	Code=5		Code=16		Code=27
	Code=6		Code=17		Code=28
	Code=7		Code=18		Code=29
	Code=8		Code=19		Code=30
	Code=9		Code=20		Code=31
	Code=10		Code=21		Code=32
	Code=11		Code=22		

- Power supply: DC 24V (supplied by adaptor)
- Power consumption: Standby 15mA, working 350mA
- Wiring: 2 wires, non-polarity

Thanks for your purchase!